

mdf italia



© COPYRIGHT 2021 MDF ITALIA SRL SOCIETA' UNIPERSONALE

2017

AXY

Designed by Claudio Bellini

Lightness combined with dynamic perception of suspension is the theme developed by the design of the new table system Axy. A basic architecture in which the original design of the two structural bridges, entirely made of aluminium, recomposes the tensions and strength lines with expressive efficacy.

A thin top completes the table, conveying an overall aerial impression underpinned by reassuring stability.

Available in various configurations, including the extendable version, with a wide choice of materials and finishes Axy naturally adapts to a broad range of interpretations both for indoor and outdoor use, from the dining-table to the working desk.

Rectangular tables available in 20 sizes and various depths, height 73cm, in the types and configurations:

- Fix: AXY and AXY COMFORT
- Extendable: AXY EXTENSION.

FRAME

AXY and AXY COMFORT: fixed bearing frame made of extruded aluminium painted in matt graphite grey.

AXY EXTENSION: bearing frame and extension mechanism produced in oxidised black extruded aluminium, running on castors with ball bearings and lateral extraction of the bridge.

Open and close lock with two levers placed on under top guides.

Storage compartment of extension tops in aluminium painted in matt graphite grey, fitted with a small non-scratch carpet.

TOPS

Tops are available in the materials: Fenix, oak, calce, pietra di Savoia and aluminium. Thickness 12 mm.

EXTENSION versions are only available in the finishes FENIX and OAK.

EXTENSIONS

The flexible features of AXY EXTENSION are underscored by the presence of two extensions, 50cm each, placed on the frame's guides. Extensions can be produced with either one or two elements. The nominal length of the table can be increased from 50 to 100cm, based on client requirements.

ACCESSORIES

The tables, in the version AXY COMFORT D120 L240/260/280/300/340/400 with tops in FENIX, WOOD and ALUMINIUM, are available in the version with electrified profile. A series of adaptors with different types of sockets and functions can be hooked to the electrified profile. Steel spring to be inserted into specific holes prepared in the lower part of the electrified raceway to collect the cables.

Finish: painted matt black.

OUTDOOR USE

Fixed versions with CALCE, PIETRA DI SAVOIA and ALLUMINIUM tops are also suitable for outdoor use.

AXY

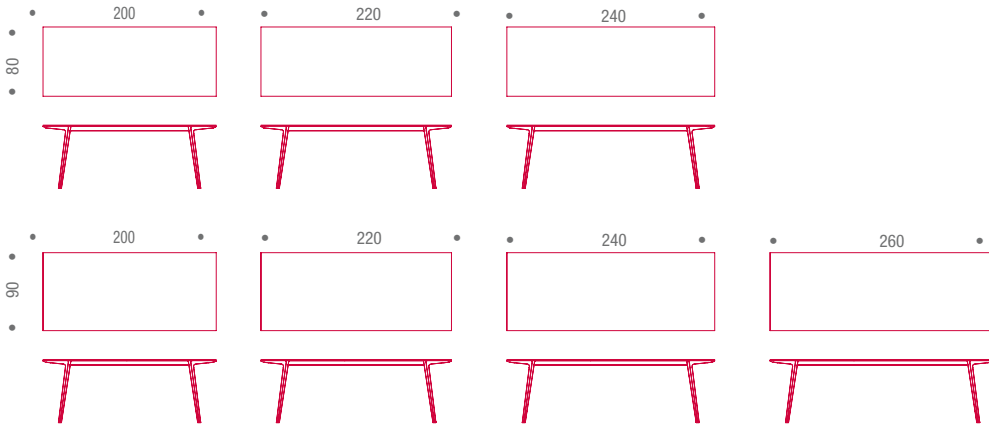

AXY EXTENSION

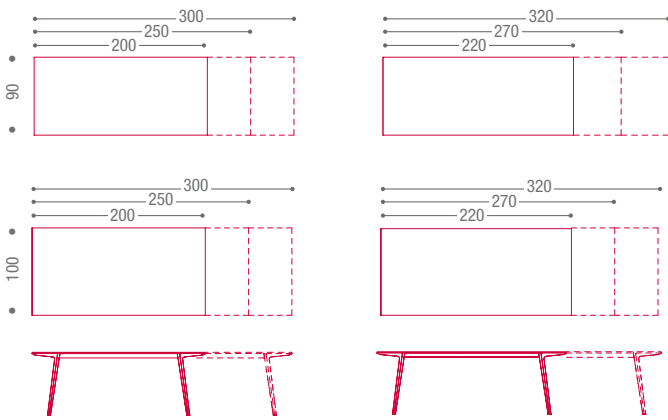

AXY COMFORT

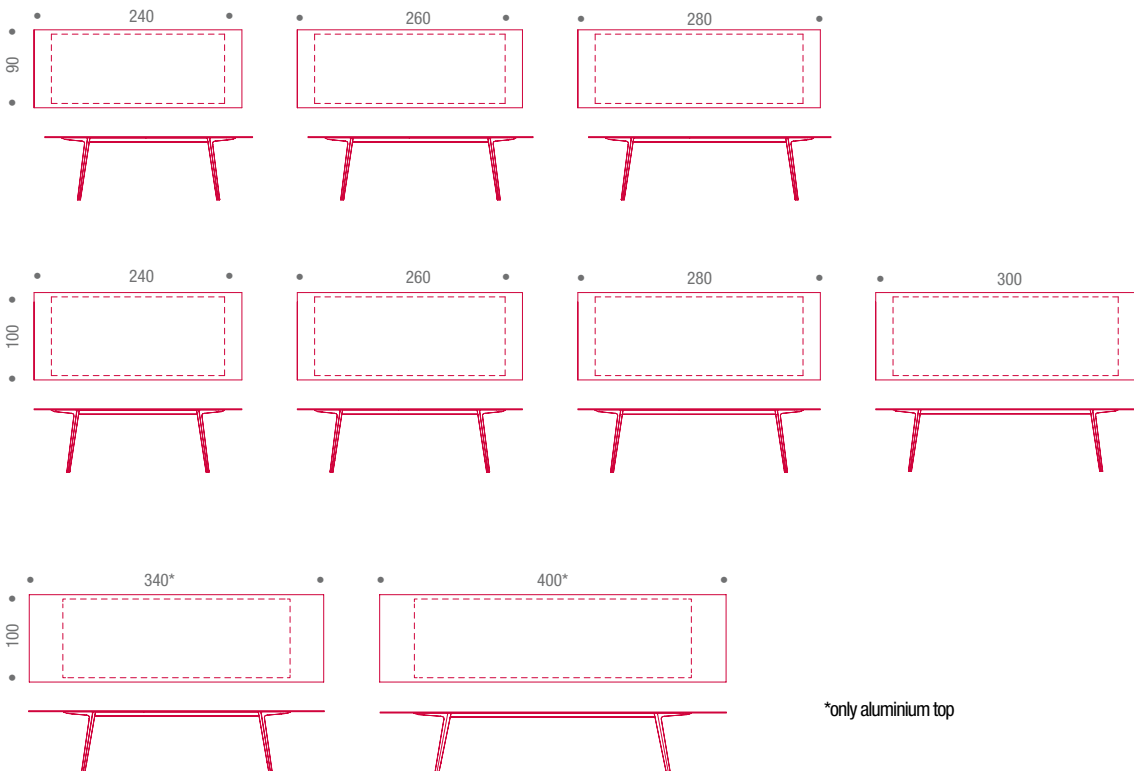

*only aluminium top

AXY COMFORT 120

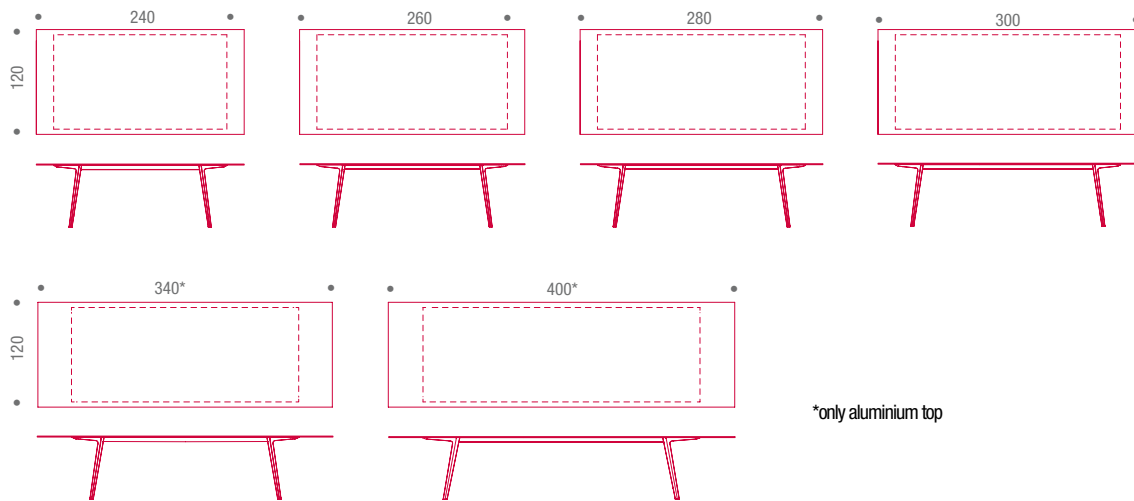

AXY COMFORT 120 WITH ELECTRIFIED PROFILE

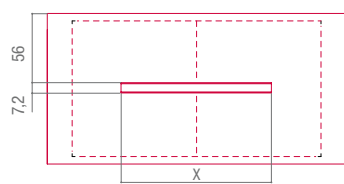
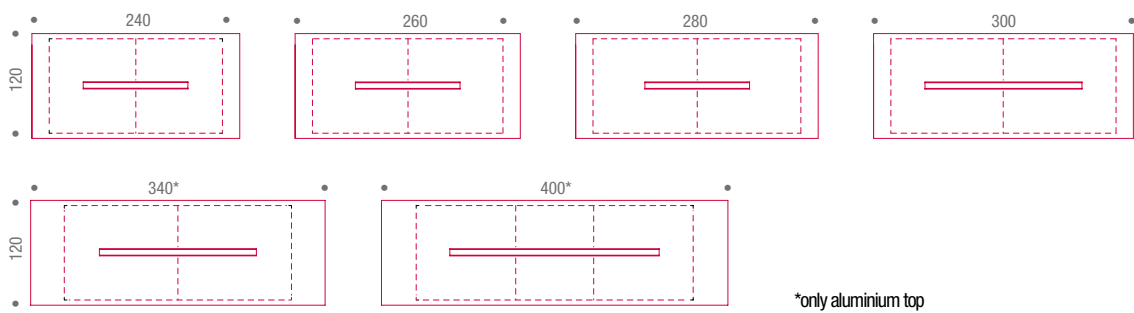

Dimensioning of raceways to collect the cables, single version (X):

L240,260,280 = 120 cm

L300,340 = 180 cm

L400 = 240 cm

Finishing

The number in the dot corresponds to the number of colour/material finish.

Here below, in the section FINISH OPTIONS, please note all the colours of the materials used for this product.

TABLE

Top



Fenix



Oak

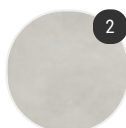

Calce



Stone



Aluminium

Structure

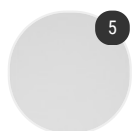

Matt painted

Finish options

TOP

Fenix



Fenix matt
white X020

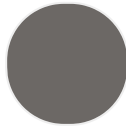

Fenix matt
medium grey
X021

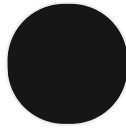

Fenix matt
black X022

Oak



Light oak
X095



Mocha oak
X096



Anthracite
oak X097

Calce



Light grey
calce



Black calce

Stone



Medium grey
pietra di
Savoia

Aluminium



Black
aluminium
X110

STRUCTURE

Matt painted

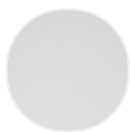

Matt painted
white X053



Matt painted
graphite grey
X054



matt titanium
paint X099



matt bronze
paint X100



matt black
nickel paint
X101