



© COPYRIGHT 2019 MDF ITALIA SRL SOCIETA' UNIPERSONALE

2013 - 2019

# MINIMA 3.0

Designed by Bruno Fattorini

Minima 3.0 by Metrica - design Bruno Fattorini.

## NOVELTIES 2019

Today Minima 3.0 evolves and renews, turning into a more versatile and adaptable furnishing system, capable of joining more functions. The new Minima 3.0 is divided into 5 types: free-standing, wall-mounted, sideboard, sketch and room divider.

In addition, for the free-standing version, two new heights are available - 188.5 and 225 - and new shelves with LED lights integration.

[Find out more about the sideboard, sketch and Room Divider versions.](#)

Minima 3.0: three stands for the three key elements that compose the system: shelf, frame, cabinets. Essential and flexible, Minima 3.0 represents the natural makeover of Minima, MDF Italia collection's icon product, special mention at the XVII Compasso D'Oro ADI in 1998. Technology and innovation have enabled this thin aluminium structure, to propose an increasingly minimal yet strong identity. The storage units (with door, flap opening door, drawers, or open) are simply resting inside the structure and are repositionable quite easily. Uprights and shelves made of matt lacquered white and graphite grey extruded aluminium (100% recyclable). Nominal lengths of cabinets: 30, 60, 90 cm, available in a matt lacquered micro-goffered finish or in a wood variant. Two options: free-standing (in 8 heights) or hanging (in 4 heights), always with a 33 cm depth.

## STRUCTURE

Uprights and shelves made of extruded aluminium and assembled together by using a concealed joining system, capable of giving the structure stability and a special resistance to loads. Minima 3.0 is entirely made of 100% recyclable aluminium.

## CABINETS

Elements made of MD-wood fibreboards.

**CABINET D33 FOR MINIMA 3.0 FREE-STANDING, HANGING, SKETCH AND ROOM DIVIDER**

**OPEN CABINET L30**



L30 D33 H35 cm

**CABINET WITH ONE OR TWO-DRAWER L60/90**



L60 D33 H35 cm

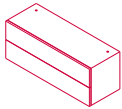

L90 D33 H35 cm



L60 D33 H15 cm

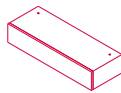

L90 D33 H15 cm

**CABINET WITH A DOOR OR A FLAP OPENING DOOR L60/90**



L60 D33 H35 cm

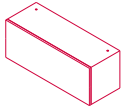

L90 D33 H35 cm

**CABINET D39 FOR MINIMA 3.0 SIDEBOARD**

**CABINET WITH FLAP OPENING DOOR OR TWO-DRAWER L90/120**

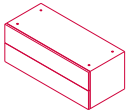

L90 D39 H35 cm

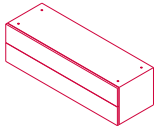

L120 D39 H35 cm

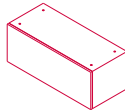

L90 D39 H35 cm

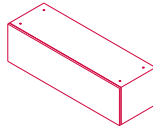

L120 D39 H35 cm

**MINIMA 3.0 | SKETCH**

**WITH MATERIAL TOP SHELF**

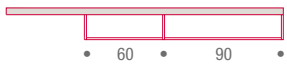

**composition MS-1**  
L210 D33 H24 cm

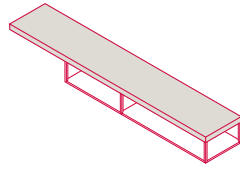

**composition MS-2**  
L240 D33 H24 cm

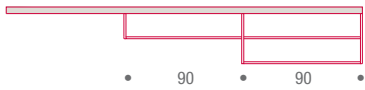
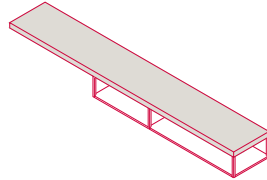

**composition MS-3**  
L270 D33 H43 cm

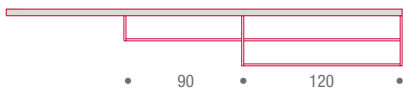
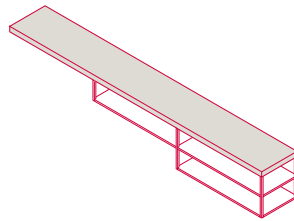

**composition MS-4**  
L300 D33 H43 cm

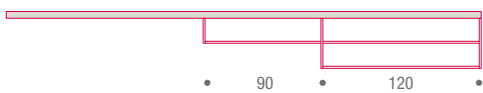
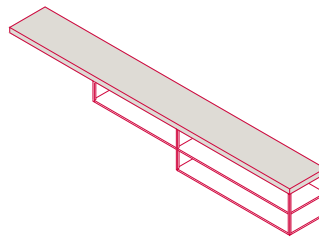

**composition MS-5**  
L360 D33 H43 cm

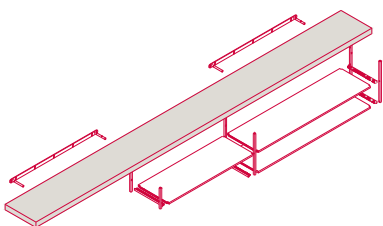
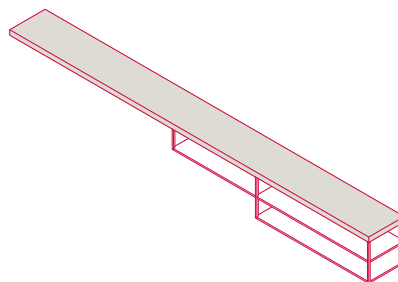

# MINIMA 3.0 | SKETCH

## WITHOUT MATERIAL TOP SHELF

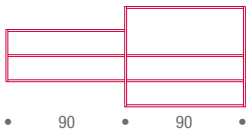

**composition S-1**  
L185 D33 H76 cm

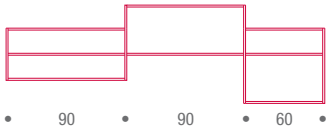
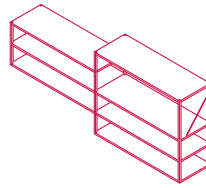

**composition S-2**  
L246 D33 H75 cm

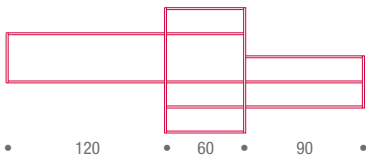
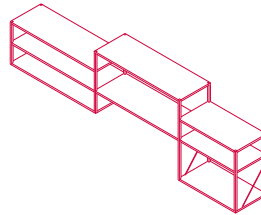

**composition S-3**  
L276 D33 H94 cm

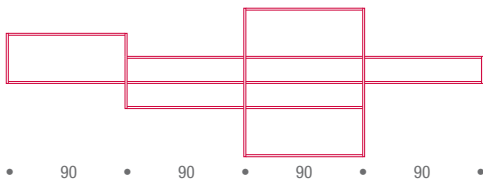
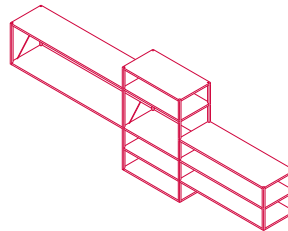

**composition S-4**  
L368 D33 H112 cm

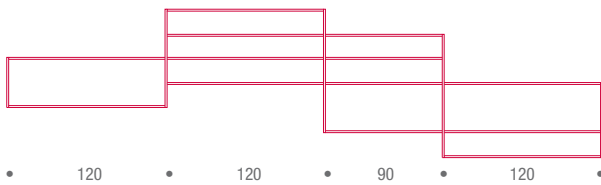
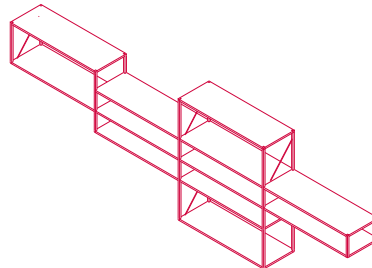

**composition S-5**  
L458 D33 H112 cm

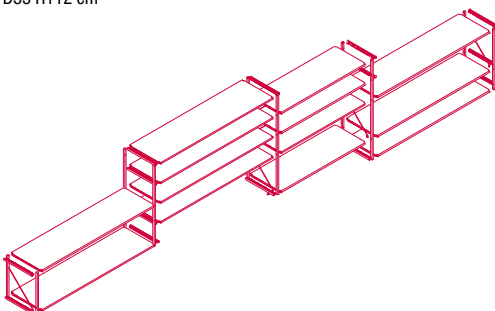
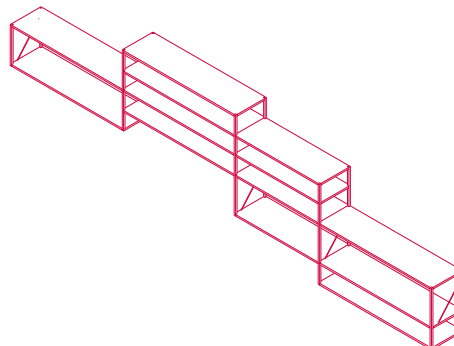

**MINIMA 3.0 | SIDEBOARD (centre of room)**

**MADIA**

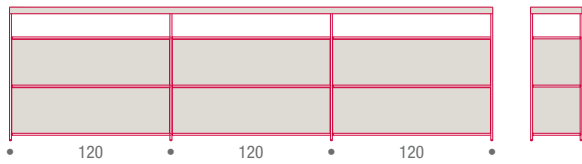

**composition 1**  
L366 D39 H101 cm

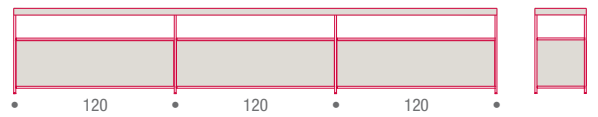

**composition 1**  
L366 D39 H65 cm

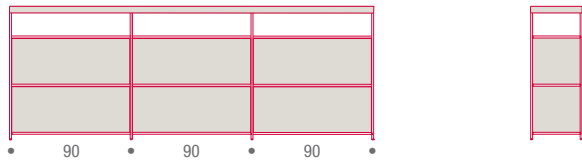

**composition 2**  
L276 D39 H101 cm

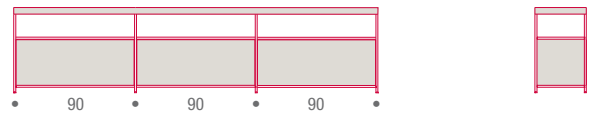

**composition 2**  
L276 D39 H65 cm

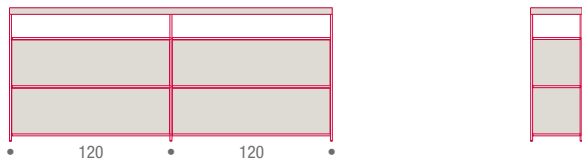

**composition 3**  
L244 D39 H101 cm

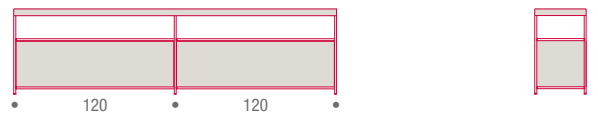

**composition 3**  
L244 D39 H65 cm

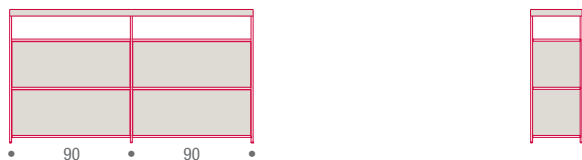

**composition 4**  
L184 D39 H101 cm

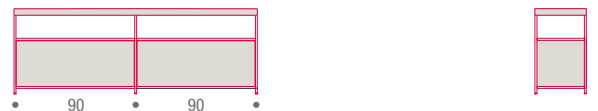

**composition 4**  
L184 D39 H65 cm

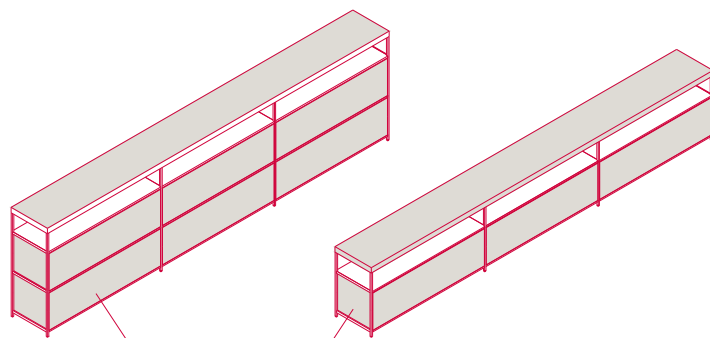

CABINETS D39 FOR MINIMA 3.0 SIDEBOARD  
WITH FLAP OPENING DOOR OR DRAWERS L90/120

**MINIMA 3.0 | ROOM DIVIDER**

**HEIGHTS**

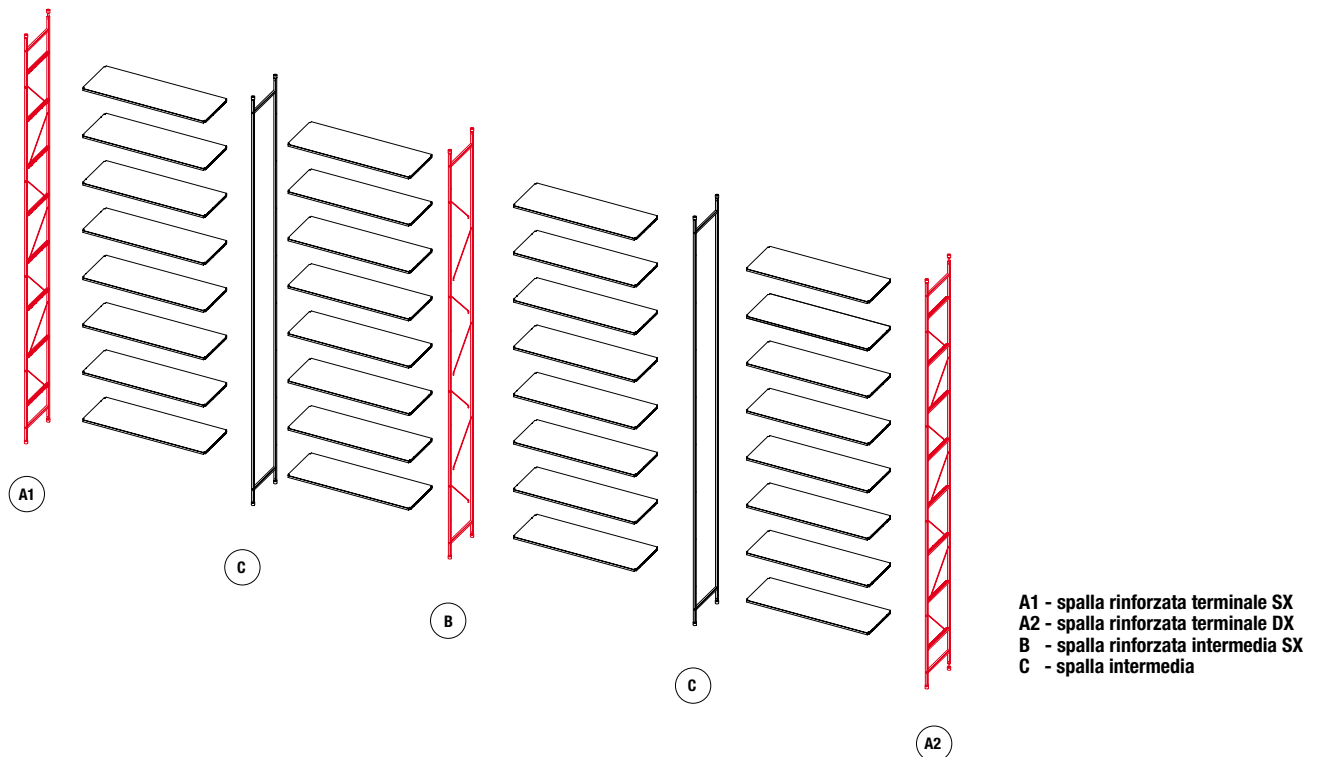
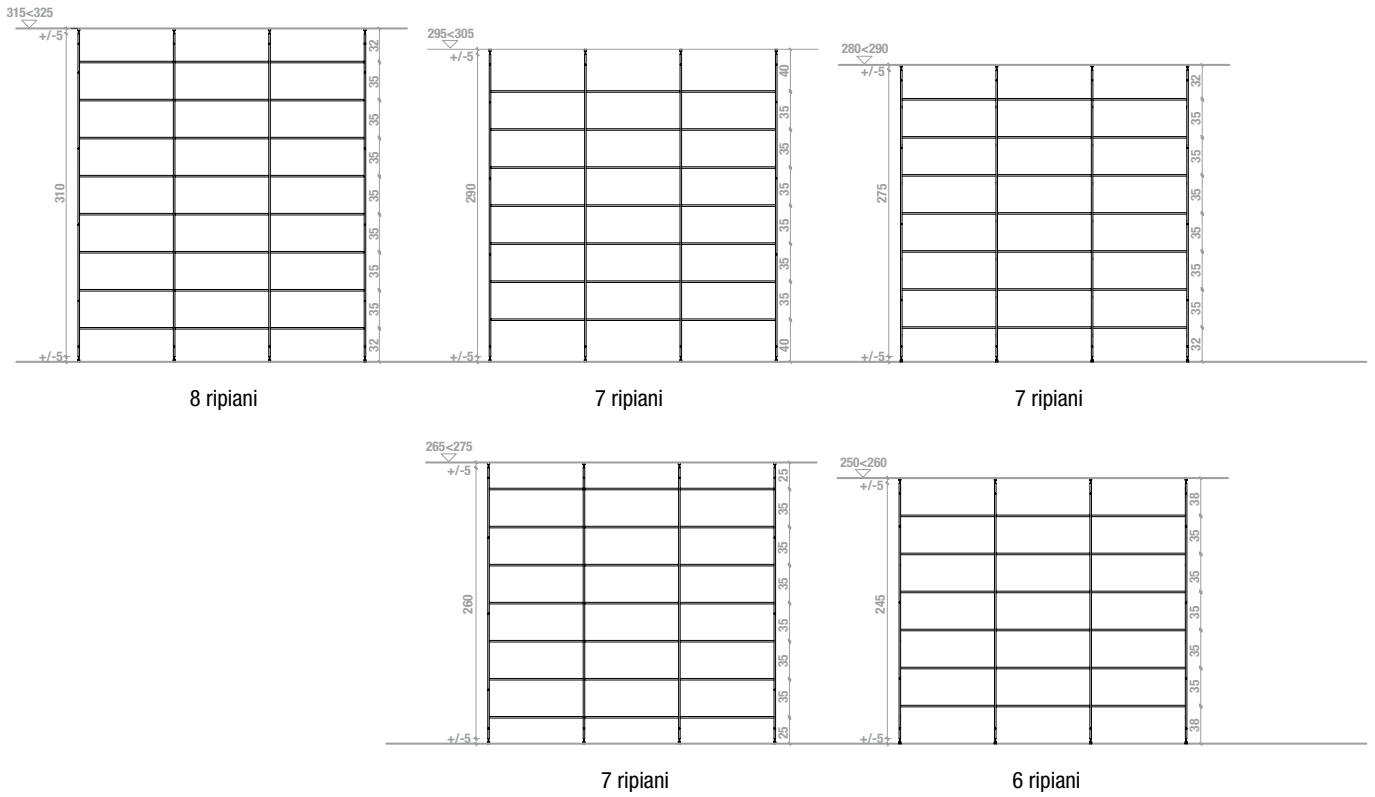

# Finishing

The number in the dot corresponds to the number of colour/material finish.

Here below, in the section FINISH OPTIONS, please note all the colours of the materials used for this product.

## SYSTEM

---

### Backrest



Backs and shelves

---

### Structure

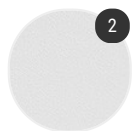

Matt painted

---

### Cabinet



Door and flap door



Drawers



Open units

# Finish options

## BACKREST

---

### Backs and shelves



Matt painted  
white X042



Natural wood  
X027



Natural grey  
wood X028



Natural black  
wood X029

## STRUCTURE

---

### Matt painted

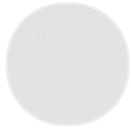

Matt painted  
white X053



Matt painted  
graphite grey  
X054

## CABINET

---

### Door and flap door



Natural black  
wood X029



Matt  
lacquered  
white X042

### Drawers



Matt  
lacquered  
white X042



Natural black  
wood X029



Open units



Natural wood  
X027



Natural grey  
wood X028



Natural black  
wood X029



Matt  
lacquered  
white X042



Matt  
lacquered  
dark red X046



Matt  
lacquered  
orange X047

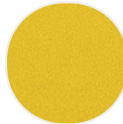

Matt  
lacquered  
mustard  
yellow X048



Matt  
lacquered  
avio blue  
X050



Matt  
lacquered  
green X049