

# mdf italia



© COPYRIGHT 2024 MDF ITALIA SRL SOCIETA' UNIPERSONALE

2013 - 2023

## MINIMA 3.0

Designed by Bruno Fattorini

Minima 3.0 by Metrica - design Bruno Fattorini.

Minima 3.0: three stands for the three key elements that compose the system: shelf, frame, cabinets.

Essential and flexible, Minima 3.0 represents the natural makeover of Minima, MDF Italia collection's icon product, special mention at the XVII Compasso D'Oro ADI in 1998. Technology and innovation have enabled this thin aluminium structure, to propose an increasingly minimal yet strong identity. The storage units (with flap opening door, drawers or open cabinets) are simply resting inside the structure and are repositionable quite easily. Uprights and shelves made of extruded aluminum (100% recyclable), matt painted finish in white, graphite grey, umbra gray and pearl nickel. The Basic cabinets are in micro-embossed matt lacquered or wood. The Extra cabinets are in Cimento or lacquered glass. Minima 3.0 is available in the ground-resting (eight heights) and hanging (four heights) variants, always in the 33 cm depth.

Minima 3.0 evolves and renews, turning into a more versatile and adaptable furnishing system, capable of joining more functions.

The new Minima 3.0 is divided into 5 types: GROUND-RESTING, HANGING, SKETCH, SIDEBBOARD AND ROOM DIVIDER. In addition, for the ground-resting version, two new heights are available - 261.5 e 298 - and new shelves with LED lights integration.

# STRUCTURE

Uprights and shelves made of extruded aluminium and assembled together by using a concealed joining system, capable of giving the structure stability and a special resistance to loads. Minima 3.0 is entirely made of 100% recyclable aluminium.

## MINIMA 3.0 GROUND-RESTING

To use this system H152, H188.5, H225 (except H261.5 and H298) as a room divider for home and work environments, it is mandatory to join two structures together so as to obtain a ground depth of 66 cm to ensure a proper stability to the system.

The wall fixing is for always suggested for heights 152 / 188.5 / 225 / 261.5 / 298 cm and for compositions with heights 42.5 / 79 / 115.5 if equipped with drawer containers.

Please note: for center-stand compositions, with heights of 42.5 / 79 / 115.5 cm, equipped with drawer containers, simultaneous opening of all drawers is not recommended, as it could cause the overturn of the structure.

## MINIMA 3.0 HANGING

Minima 3.0 in the hanging version comes in four heights: 38 / 74.5 / 111 / 147.5 cm. Inner height of compartments is always 35 cm.

# CABINETS

## BASIC CABINETS

The cabinets can be with open, flap opening doors or drawers. They are simply resting inside the structure and are repositionable quite easily, thus allowing to meet any storage requirements as desired and to choose your own lifestyle by using different colours, woods and shapes.

## EXTRA CABINETS

Minima 3.0 now sees the addition of a new storage unit that brings this historic shelving bang up to date and in line with new architectonic and contemporary living styles. Formality, minimalism, careful details and new finishes are the signature features confirmed and innovated in the new units added to the existing ones. The door is further enhanced by two main materials: rearlacquered glass and grooved Cimento®.

# Minima 3.0 Basic cabinets

## Abacus

### Basic cabinets D33 for Minima 3.0 Ground-resting, Hanging, Sketch and Room divider

#### Open cabinet L30



L30 D33 H35

#### Cabinets with flap opening door L60/90

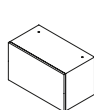

L60 D33 H35

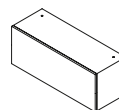

L90 D33 H35

#### Cabinets with two drawers L60/90



L60 D33 H35

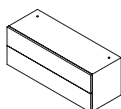

L90 D33 H35

#### Cabinets with one drawer L60/90 - Only for Sketch compositions



L60 D33 H16

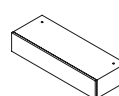

L90 D33 H16

### Basic cabinets D39 for Minima 3.0 Sideboard

#### Cabinets with flap opening door L90/120

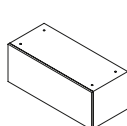

L90 D39 H35

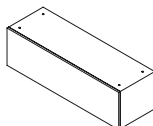

L120 D39 H35

#### Cabinets with two drawers L90/120

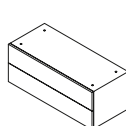

L90 D39 H35

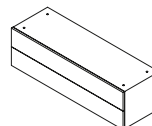

L120 D39 H35

### Lock for cabinet, upon request

#### Flap door



#### Drawers

For the cabinets with two drawers, the lock can only be put on the top drawer.

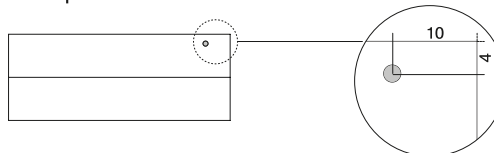

### Shelves

In the price list the shelving lengths are nominal and correspond to the inner usable space of the bookcase.

Shelf D30 for Minima 3.0 ground-resting only, NOT available with LED.

Shelves for Sideboard composition have depth 39 cm

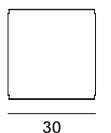

nominal L30  
real L31.5

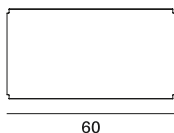

nominal L60  
real L61.5

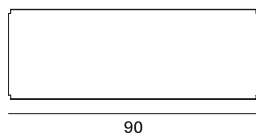

nominal L90  
real L91.5



nominal L120  
real L121.5

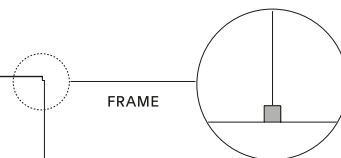

# Minima 3.0 Extra cabinets

## Abacus

---

### Extra Cabinets D33 for Minima 3.0 Ground-resting, Hanging and Room divider

---

Cabinets with flap opening door L60/90/120  
in grooved Cimento



L60 D33 H35

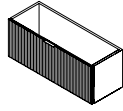

L90 D33 H35

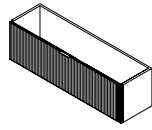

L120 D33 H35

Cabinets with flap opening door L60/90/120  
in rear-lacquered glass



L60 D33 H35

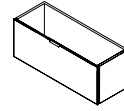

L90 D33 H35

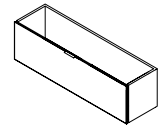

L120 D33 H35

---

Cabinets with two drawers L60/90/120  
in grooved Cimento



L60 D33 H35

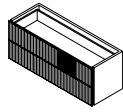

L90 D33 H35

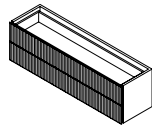

L120 D33 H35

---

Cabinets with two drawers L60/90/120  
in rear-lacquered glass



L60 D33 H35

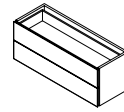

L90 D33 H35

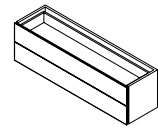

L120 D33 H35

# Minima 3.0 Extra cabinets

## Abacus

### End or intermediate panel for Extra cabinets

To complete the order of the Extra cabinets, it is necessary to add the end panel (LH/RH) or intermediate panel (INT), depending on the composition. Below are some examples of use in relation to the position of the cabinets.

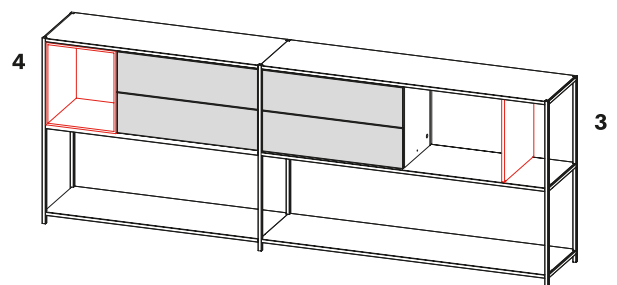
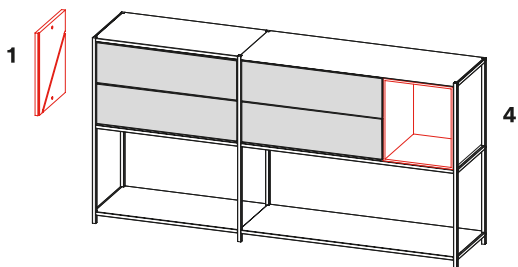
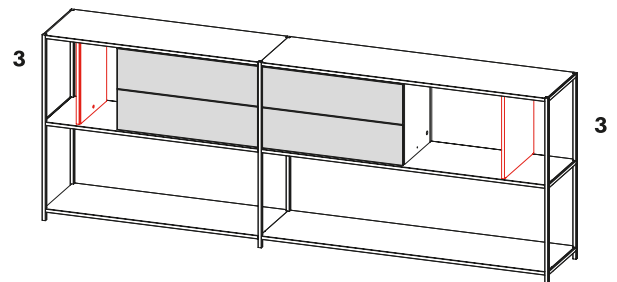
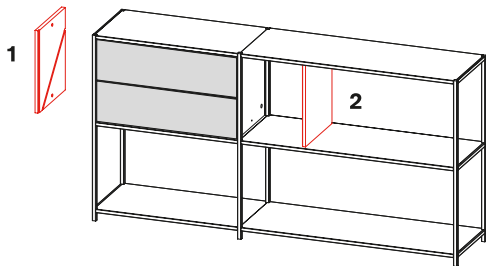
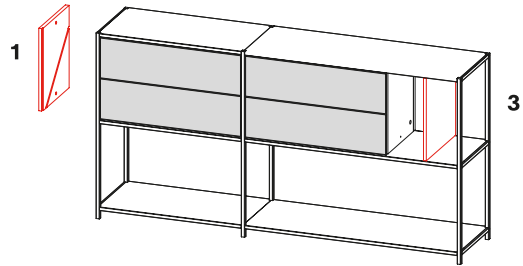
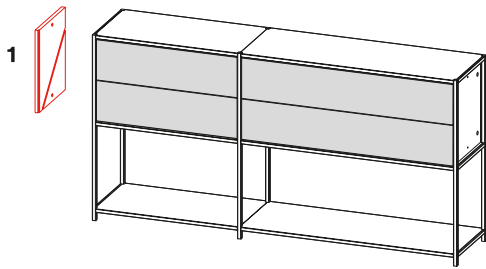

- 1 Left-hand end cap L
- 2 Right-hand end cap R
- 3 Intermediate cap C
- 4 Open cabinet

# Minima 3.0 ground-resting

## Abacus

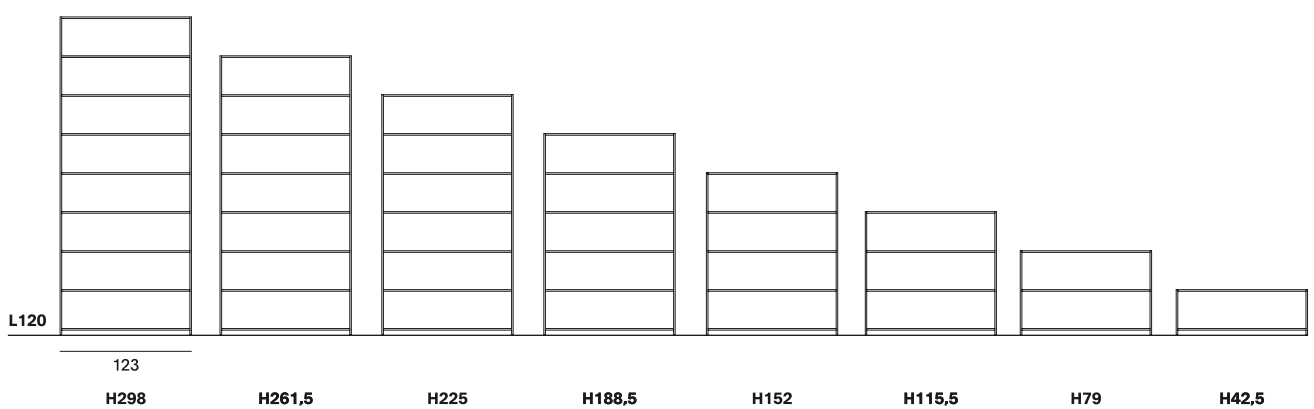
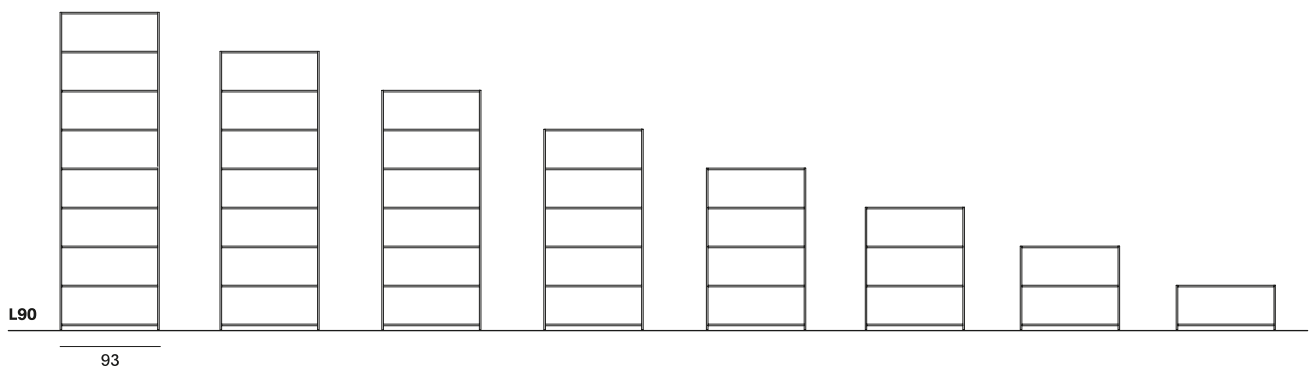
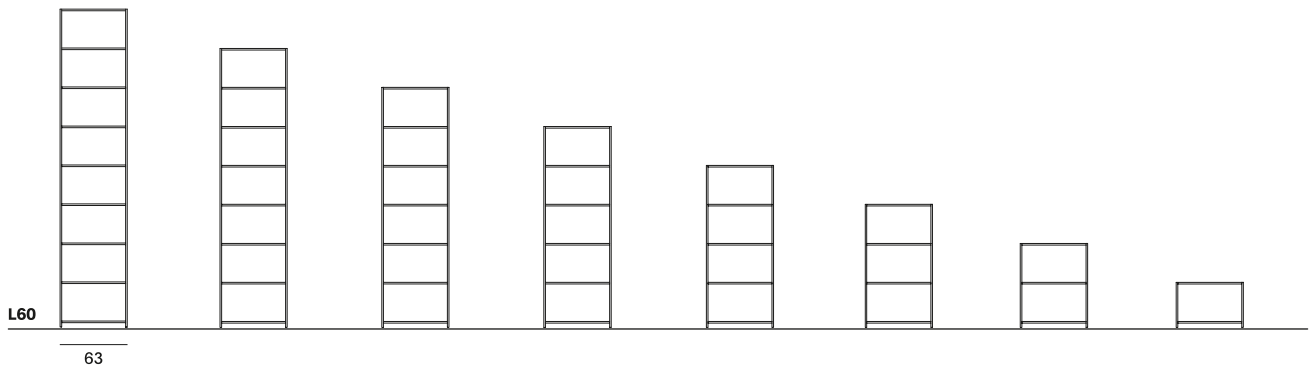
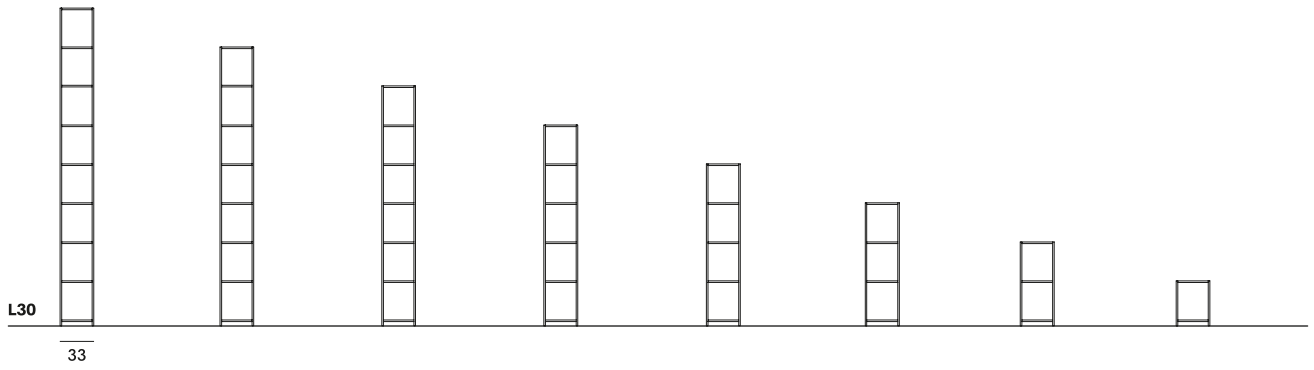

# Minima 3.0 ground-resting

Abacus

Elements

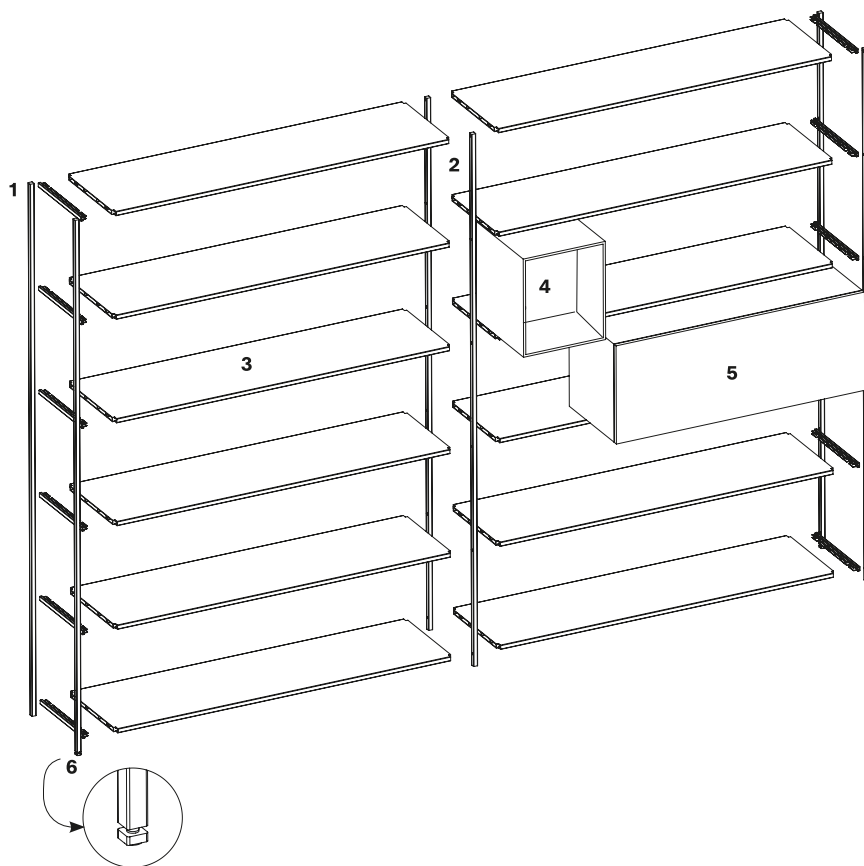

**1 ground-resting end frame**  
completed with fittings

**2 ground-resting intermediate frame**

**3 shelf**

**4 open cabinet, L30**

**5 cabinet**

**6 adjustable feet**

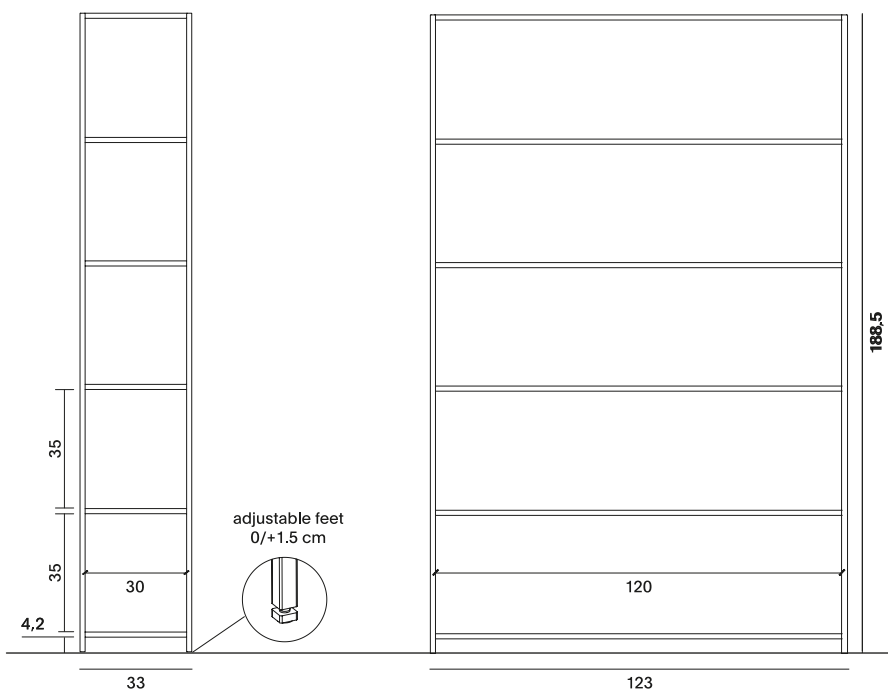

33

123

# Minima 3.0 ground-resting

## Abacus

A drawing of the composition with the TV position must be sent together with your order.

For ground variant only with 120 cm long shelving and in heights 115.5 cm, 152 cm, 188.5 cm, 225 cm, 261.5 cm and 298 cm the bookcase can be set up to support a TV set. With these variants, just one shelf can be removed, thus getting a 71.5×120 cm useful space, that is compatible for up to 46" TV sets (a size that may vary depending on brand and model).

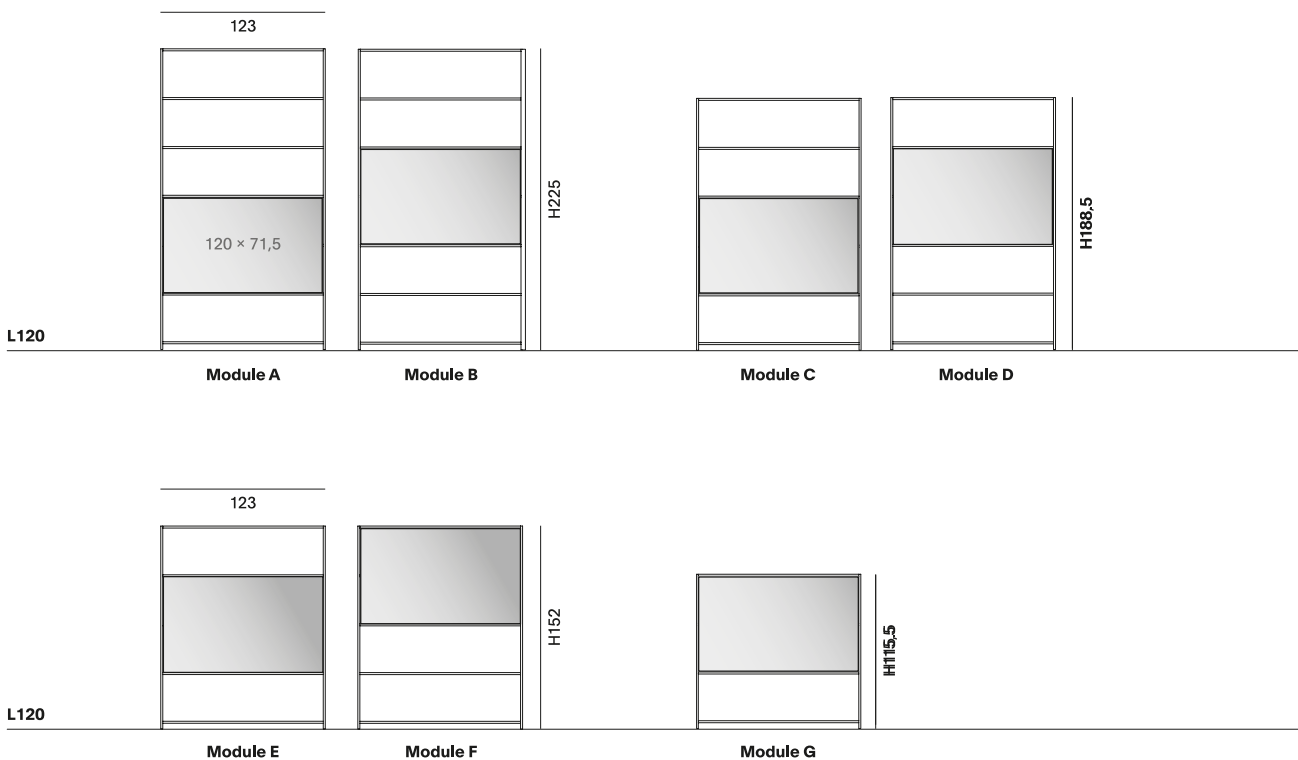

### Please note

Please be informed that it is necessary to order two caps for each shelf for a composition with TV unit placed in intermediate position.

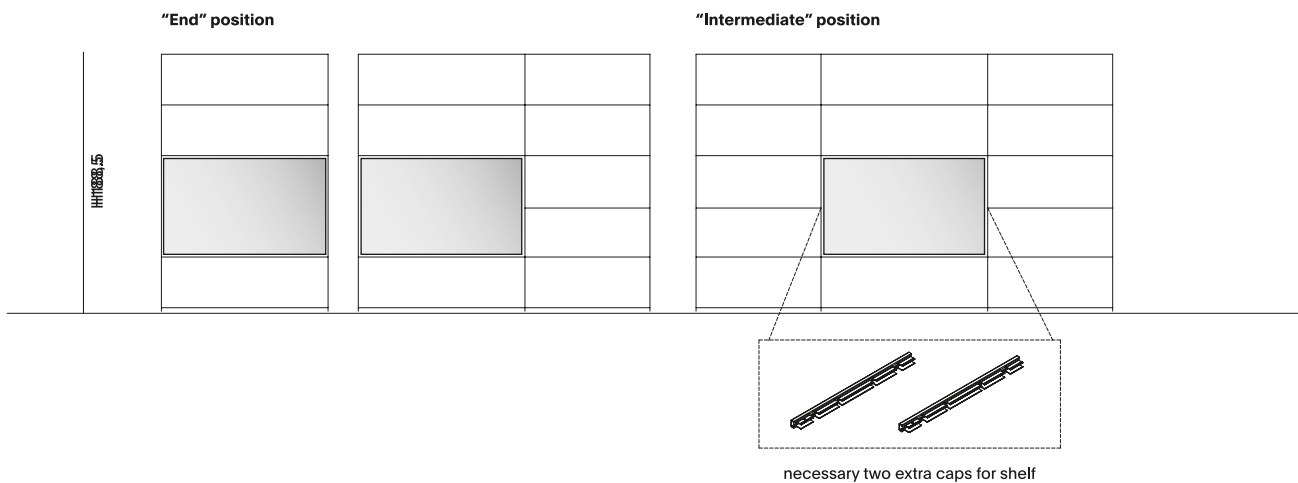



# Minima 3.0 ground-resting

Abacus

## Rules for compositions with integrated led

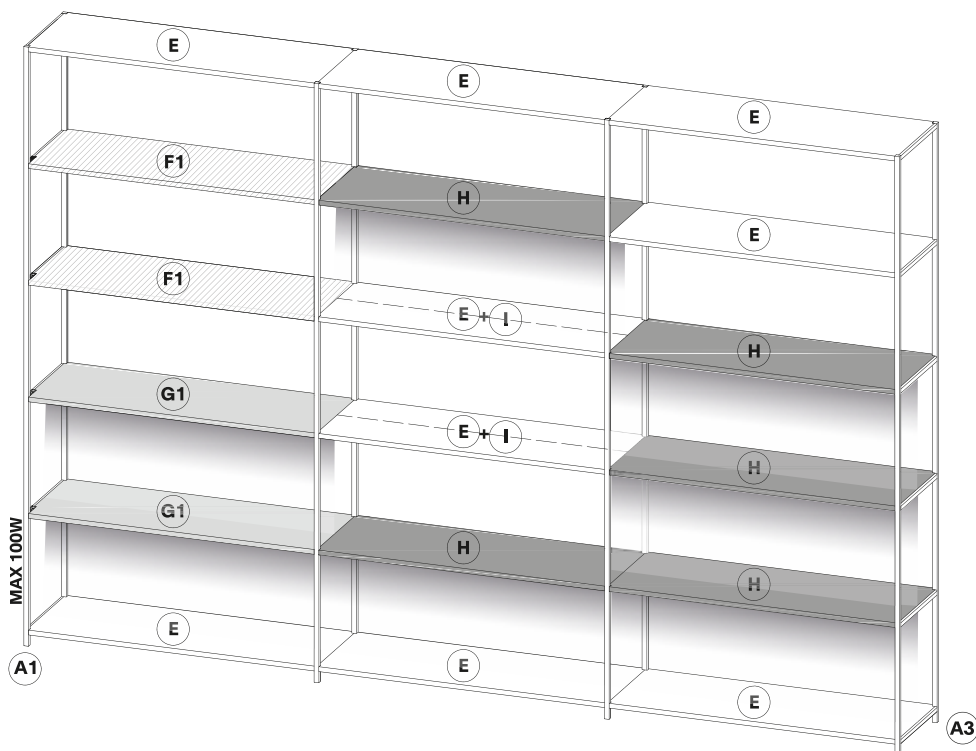

## Power for led compositions

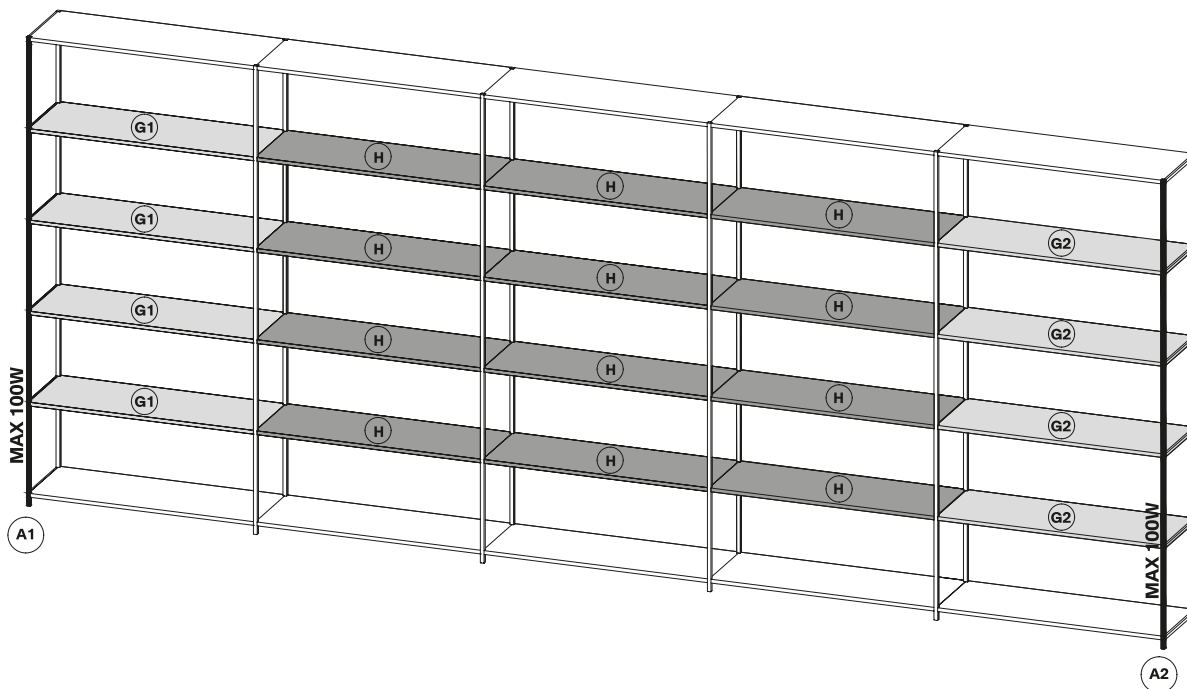

Electrified frames for all heights 100 W

In the above example:  
 20 shelves with led cm 90 =  $20 \times 10 W = 200 W^*$

\*maximum power limit for 2 electrified frames

Scheme to establish the number of electrified frames and maximum number of shelves that can be provided with led

Length of the shelf with led	Watt consumption for each shelf
60 cm	6.5 W
90 cm	10 W
120 cm	13.5 W

# Minima 3.0 ground-resting

## Abacus

### Shelves



E STANDARD shelf



F1 LEFT end shelf with CONNECTOR



F2 RIGHT end shelf with CONNECTOR

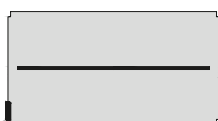

G1 LEFT end shelf with CONNECTOR AND LIGHT

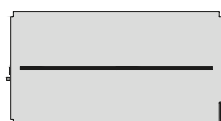

G2 RIGHT end shelf with CONNECTOR AND LIGHT



H end/intermediate shelf with LIGHT

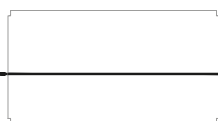

I EXTENSION KIT

### Frames

A1 electrified frame left - max power 100 W

A2 electrified frame right - max power 100 W

A3 end frame, not electrified



#### PLEASE NOTE

- THE ELECTRIFIED FRAME IS ALWAYS IN FRONT.
- LEFT LH OR RIGHT RH ELECTRIFIED UPRIGHT TO BE SELECTED ACCORDING TO THE CUSTOMER NEEDS, OR TO THE POSITION OF THE ELECTRICAL OUTLET.
- MAX 2 ELECTRIFIED FRAMES PER COMPOSITION.
- THE SIMULTANEOUS USE OF THE LEFT LH AND RIGHT RH ELECTRIFIED UPRIGHT IS NECESSARY ONLY IF THE POWER INDICATED IN THE SCHEME (100 W PER UPRIGHT) IS EXCEEDED.
- MAX HEIGHT OF THE FRAME 298 CM.
- US/EU/UK PLUG TO BE PURCHASED ACCORDING TO THE NUMBER OF ELECTRIFIED FRAMES.

### D33 shelves

E standard shelf

F1 left end shelf with connector

F2 right end shelf with connector

G1 left end shelf with connector and light

G2 right end shelf with connector and light

H end/intermediate shelf with light

I extension kit (to be inserted by the customer)

### Electric scheme of leds

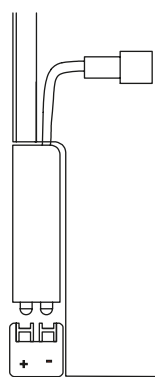

Detail of the connection of electrified frame

A1

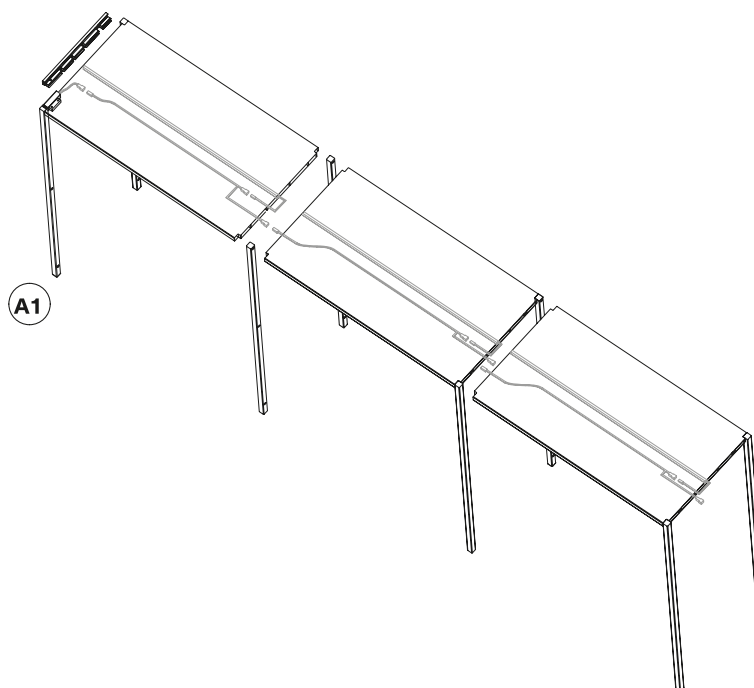

# Minima 3.0 ground-resting

## Abacus

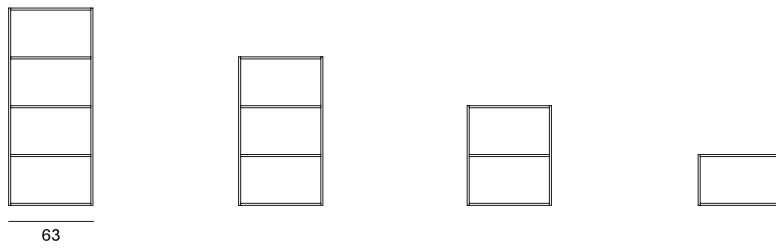

L60

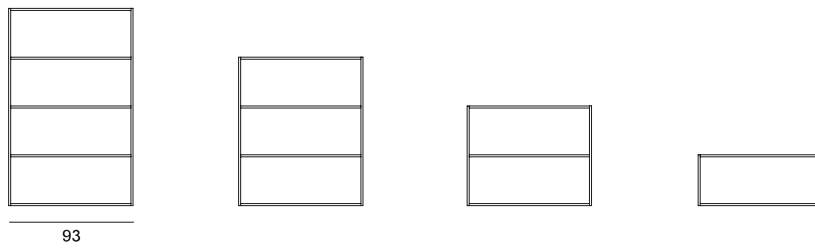

L90

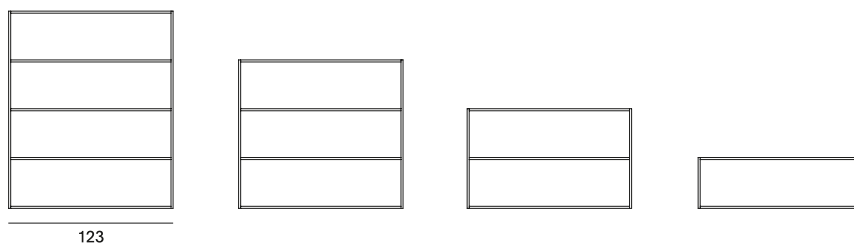

L120

H147,5

H111

H74,5

H38

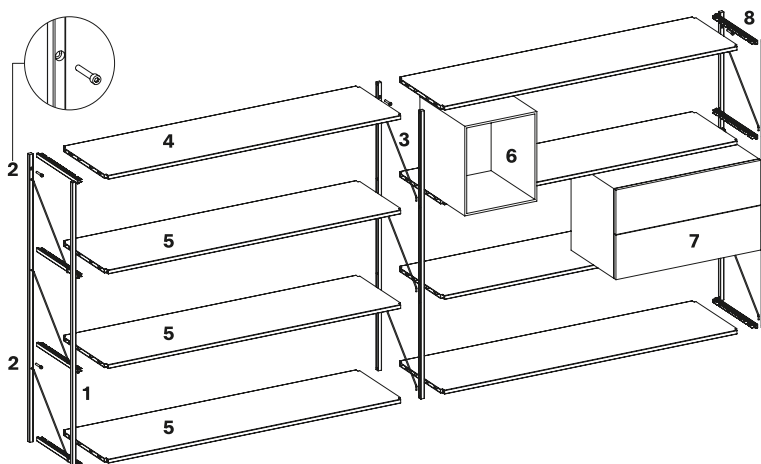

- 1 hanging end frame (L),  
completed with fittings and tie rods
- 2 wall-fixing
- 3 hanging intermediate frame with tie rods
- 4 top shelf
- 5 shelves (base and intermediate)
- 6 open cabinet, L30
- 7 two-drawer cabinet
- 8 hanging end frame (R),

# Minima 3.0 Sketch

## Abacus

composition S-1 L185 D33 H74.5

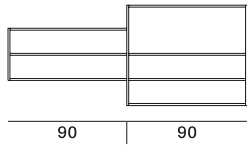

composition S-2 L246 D33 H74.5

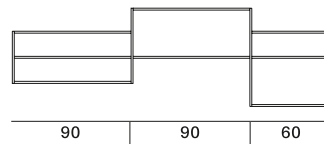

composition S-3 L276 D33 H93

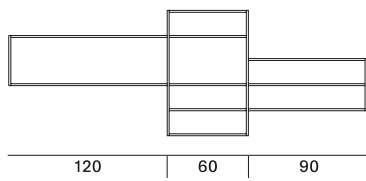

composition S-4 L368 D33 H110

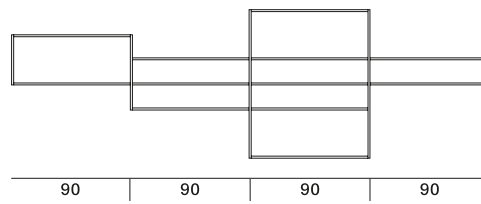

composition S-5 L458 D33 H110

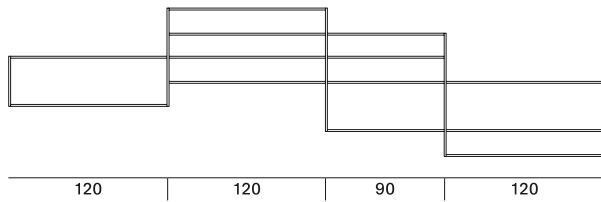

# Minima 3.0 Sideboard

## Abacus

composition SB-1 L184 D39 H64  
2 cabinets L90 to be added (mandatory)

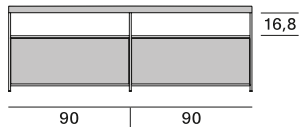

composition SB-1 L184 D39 H100  
4 cabinets L90 to be added (mandatory)

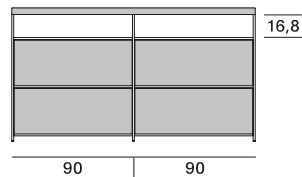

composition SB-2 L244 D39 H64  
2 cabinets L120 to be added (mandatory)

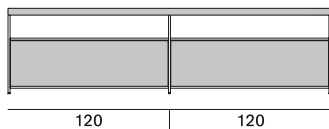

composition SB-2 L244 D39 H100  
4 cabinets L120 to be added (mandatory)

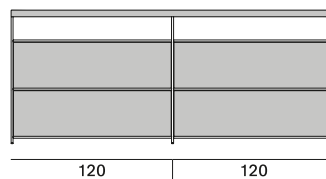

composition SB-3 L276 D39 H64  
3 cabinets L90 to be added (mandatory)

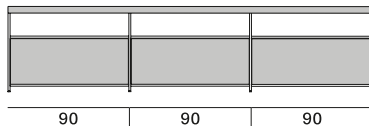

composition SB-3 L276 D39 H100  
6 cabinets L90 to be added (mandatory)

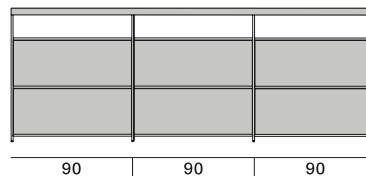

composition SB-4 L366 D39 H64  
3 cabinets L120 to be added (mandatory)

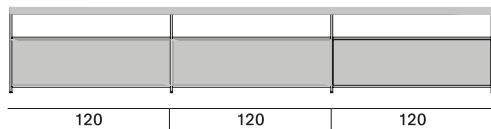

composition SB-4 L366 D39 H100  
6 cabinets L120 to be added (mandatory)

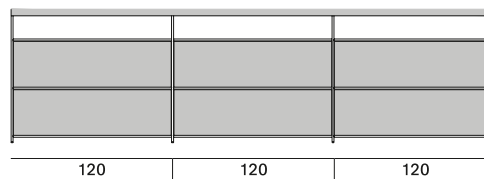

### PLEASE NOTE

CABINETS MANDATORY TO BE ADDED

CABINETS D39 FOR MINIMA 3.0 SIDEBOARD ARE WITH FLAP OPENING

DOOR OR DRAWERS L90/120.

# Minima 3.0 Room Divider

## Abacus

### Example of configuration with 7 shelves

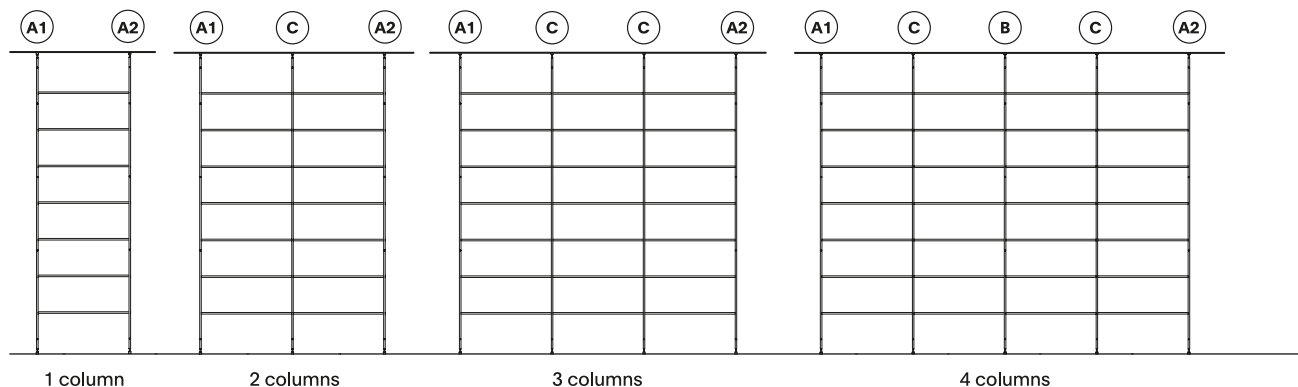

Width of the compositions and pairing of the shelves.

Please note: compositions max 6 columns. Mixed compositions, eg: 60 + 90 + 60, are not allowed

60	120 (60+60)	180 (60+60+60)	240 (60+60+60+60)
90	180 (90+90)	270 (90+90+90)	360 (90+90+90+90)
120	240 (120+120)	360 (120+120+120)	480 (120+120+120+120)

### List of components of the end frame

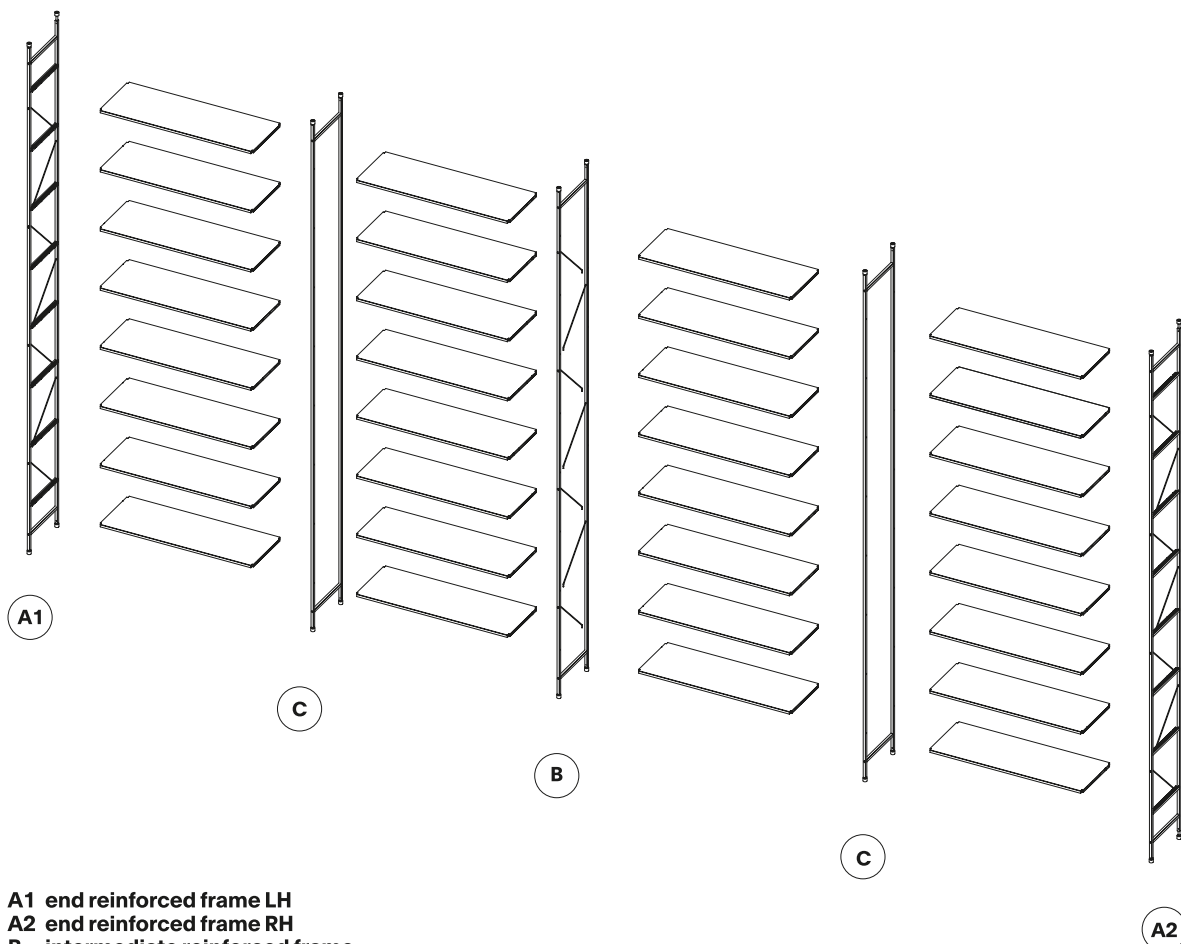

- A1 end reinforced frame LH
- A2 end reinforced frame RH
- B intermediate reinforced frame
- C intermediate frame

# Minima 3.0 Room Divider

## Abacus

### Example of configuration with 7 shelves

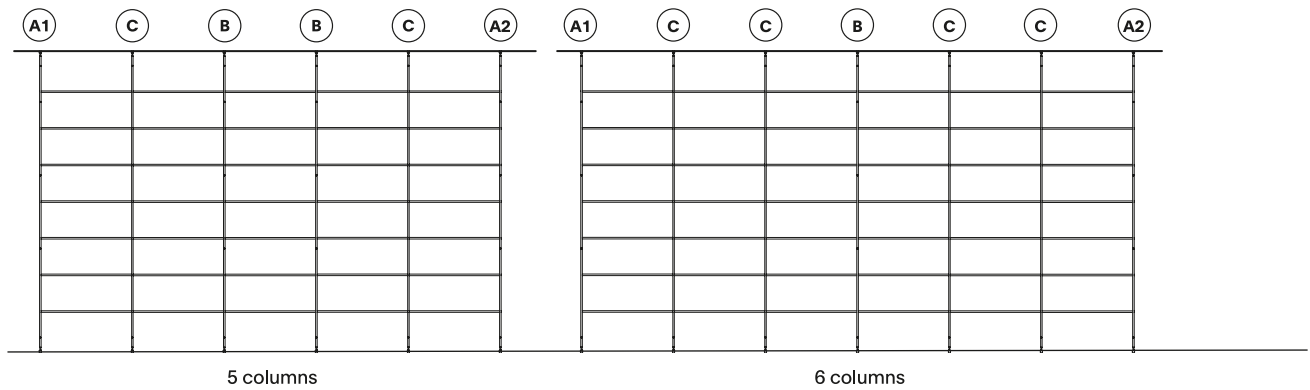

Width of the compositions and pairing of the shelves.

Important: compositions max 6 columns. Mixed compositions, eg: 60 + 90 + 60, are not allowed

300 (60+60+60+60+60)
450 (90+90+90+90+90)
600 (120+120+120+120+120)

360 (60+60+60+60+60+60)
540 (90+90+90+90+90+90)
720 (120+120+120+120+120+120)

# Minima 3.0 Room Divider

## Abacus

### Heights

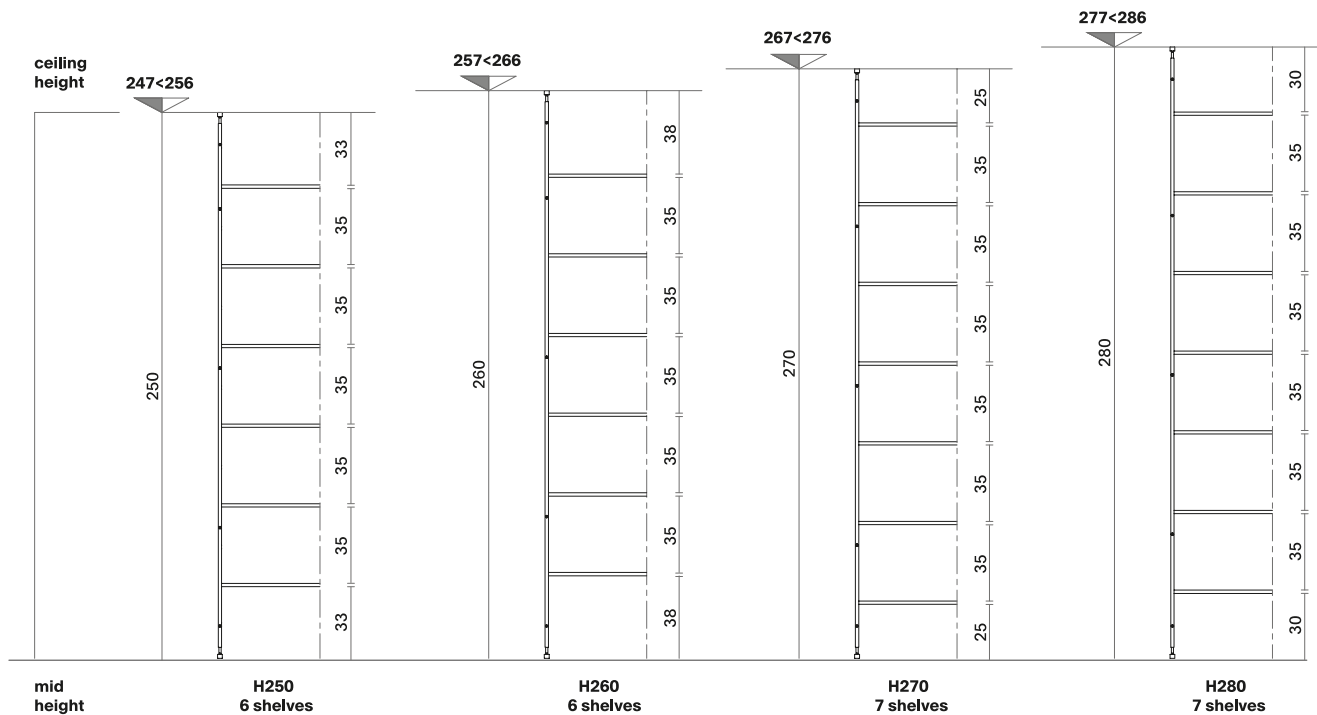

### Heights on request

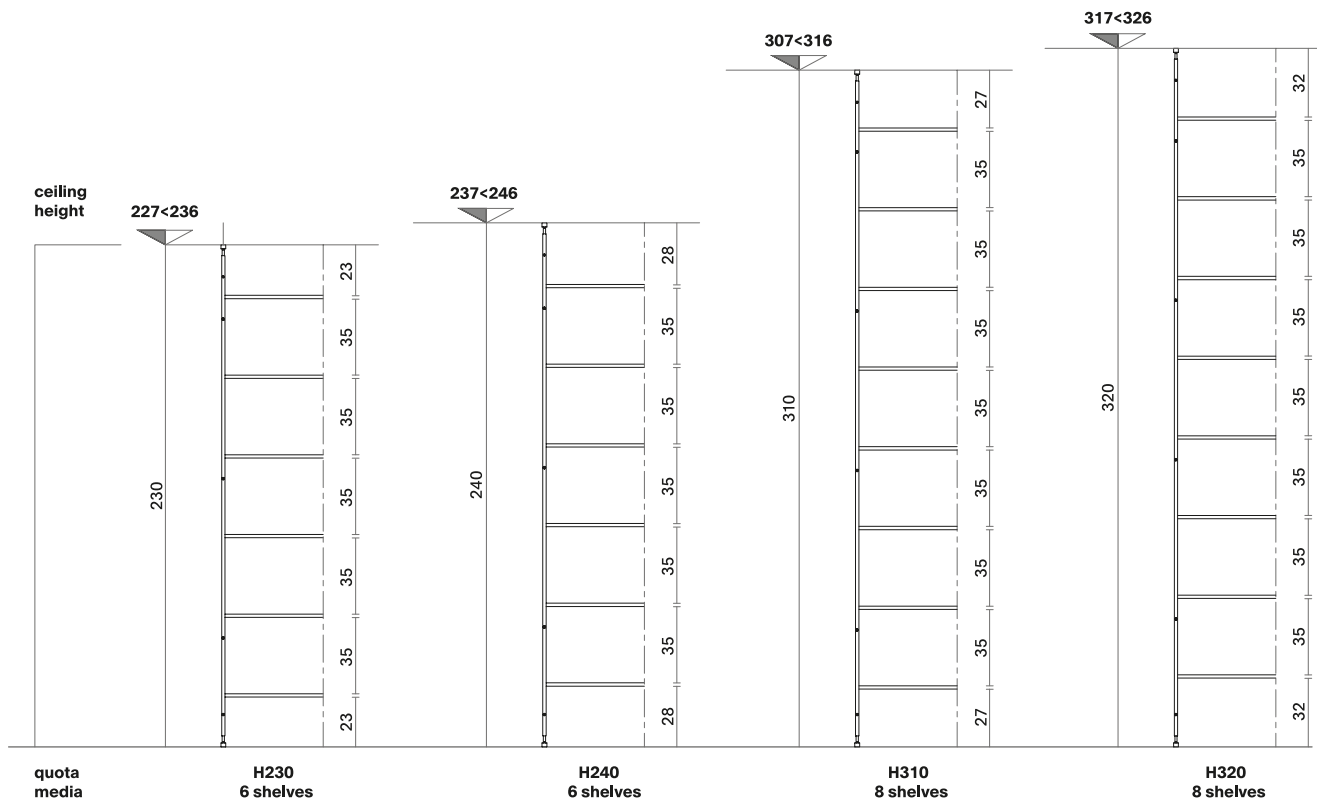



# Minima 3.0 Room Divider

## Abacus

### Heights

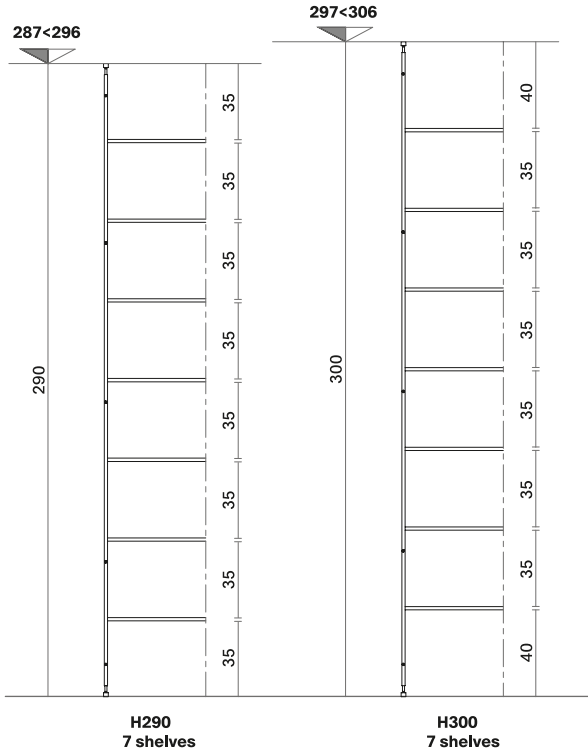

### Minimum adjustment

### Maximum adjustment

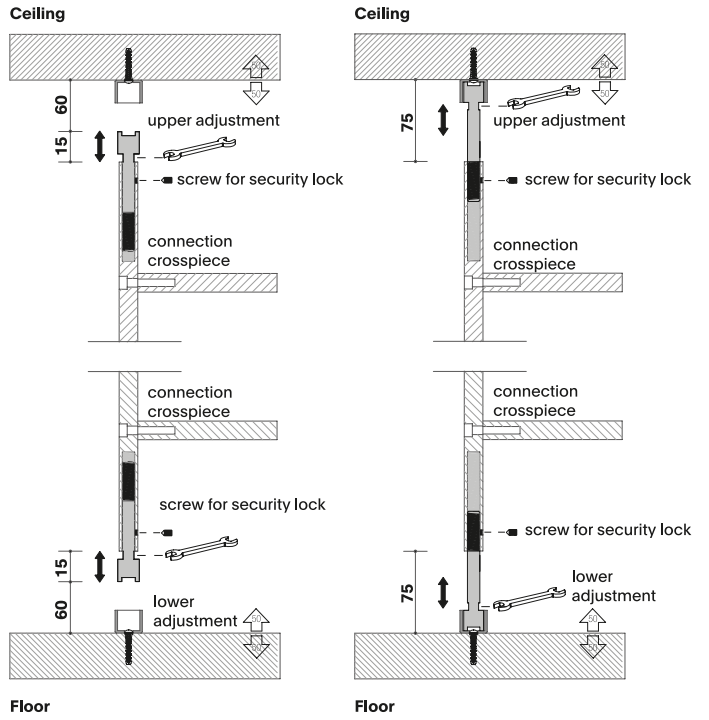

### Elements needed for custom heights

Feasibility, prices and delivery times are to be verified with our sales department.

No. columns	height	A1	A2	B	C	shelf	hanging shelf	end shelf	end shelf
		reinforced end frame L	reinforced end frame R	reinforced intermediate frame	intermediate frame	D33	D33	L D33	R D33
1 column	H230	1	1	-	-	1	5	-	-
	H240	1	1	-	-	1	5	-	-
	H310	1	1	-	-	1	7	-	-
	H320	1	1	-	-	1	7	-	-
2 columns	H230	1	1	-	1	2	-	5	5
	H240	1	1	-	1	2	-	5	5
	H310	1	1	-	1	2	-	7	7
	H320	1	1	-	1	2	-	7	7
3 columns	H230	1	1	-	2	8	-	5	5
	H240	1	1	-	2	8	-	5	5
	H310	1	1	-	2	10	-	7	7
	H320	1	1	-	2	10	-	7	7
4 columns	H230	1	1	1	2	4	-	10	10
	H240	1	1	1	2	4	-	10	10
	H310	1	1	1	2	4	-	14	14
	H320	1	1	1	2	4	-	14	14
5 columns	H230	1	1	2	2	5	5	10	10
	H240	1	1	2	2	5	5	10	10
	H310	1	1	2	2	5	7	14	14
	H320	1	1	2	2	5	7	14	14
6 columns	H230	1	1	1	4	16	-	10	10
	H240	1	1	1	4	16	-	10	10
	H310	1	1	1	4	20	-	14	14
	H320	1	1	1	4	20	-	14	14

# Finishing

The number in the dot corresponds to the number of colour/material finish.

Here below, in the section FINISH OPTIONS, please note all the colours of the materials used for this product.

## SYSTEM

---

### Structure

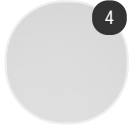

Matt painted

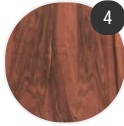

Material top

---

### Cabinet



Open units



Basic flap door and drawers

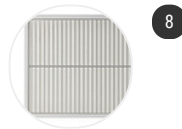

Extra flap door and drawers

# Finish options

## STRUCTURE

---

### Matt painted

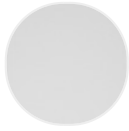

Matt painted  
white X053



Matt painted  
graphite grey  
X054



Matt painted  
shadow grey  
X122



Matt painted  
nickel pearl  
X123

### Material top



Italian walnut  
(fine wood)  
X119



Reconstructed  
stone black  
slate X132



Reconstructed  
stone X084



Reconstructed  
stone white  
Calce X131

## CABINET

---

### Open units



Matt  
lacquered  
navy blue  
X165



Matt  
lacquered  
avio blue  
X050



Matt  
lacquered  
English green  
X164



Matt  
lacquered  
green X049



Matt  
lacquered  
burgundy  
X163



Matt  
lacquered  
dark red X046

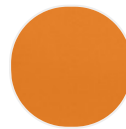

Matt  
lacquered  
orange X047

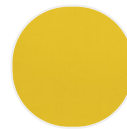

Matt  
lacquered  
mustard  
yellow X048



Matt  
lacquered  
dune X162



Matt  
lacquered  
white X042



Fine wood,  
Italian walnut  
X119



Matt  
lacquered  
shadow grey



Matt  
lacquered  
nickel pearl

## Basic flap door and drawers



Matt  
lacquered  
white X042



Matt  
lacquered  
shadow grey



Matt  
lacquered  
pearl nickel



Natural black  
wood X029

## Extra flap door and drawers



White  
grooved  
Cimento X150



Graphite grey  
grooved  
Cimento X151



Shadow grey  
grooved  
Cimento X152



Pearl nickel  
grooved  
Cimento X153



Lacquered  
glass White  
X011



Lacquered  
glass black  
X012



Lacquered  
glass  
shadow grey  
X148



Lacquered  
glass pearl  
nickel X149